

# Photo Module for PCM Remote Control Systems

## Description

The **GT438R** is miniaturized receiver for use infrared carrier frequency PCM remote control systems. A photo PIN diode and a low noise preamplifier are assembled on lead frame, the epoxy package is designed as IR filter.

The demodulated output signal can directly be decoded by a microprocessor. The main benefit is the reliable function even in disturbed ambient and the protection against uncontrolled output pulses.



## Features

- Photo detector and Preamplifier in one package
- Internal filter for PCM frequency
- TTL and CMOS compatibility
- Output active low
- Wide supply voltage & low current dissipation
- Suitable burst length  $\geq 15$  cycles/burst

## Special Features

- Enhanced immunity against all kinds of disturbance light
- No occurrence of disturbance pulses at the output

## Applications

TV, VTR, Acoustic Devices, Air Conditioner, Car Stereo Units, Computers, Interior controlling appliances, and all appliances that require remote controlling

## Block Diagram

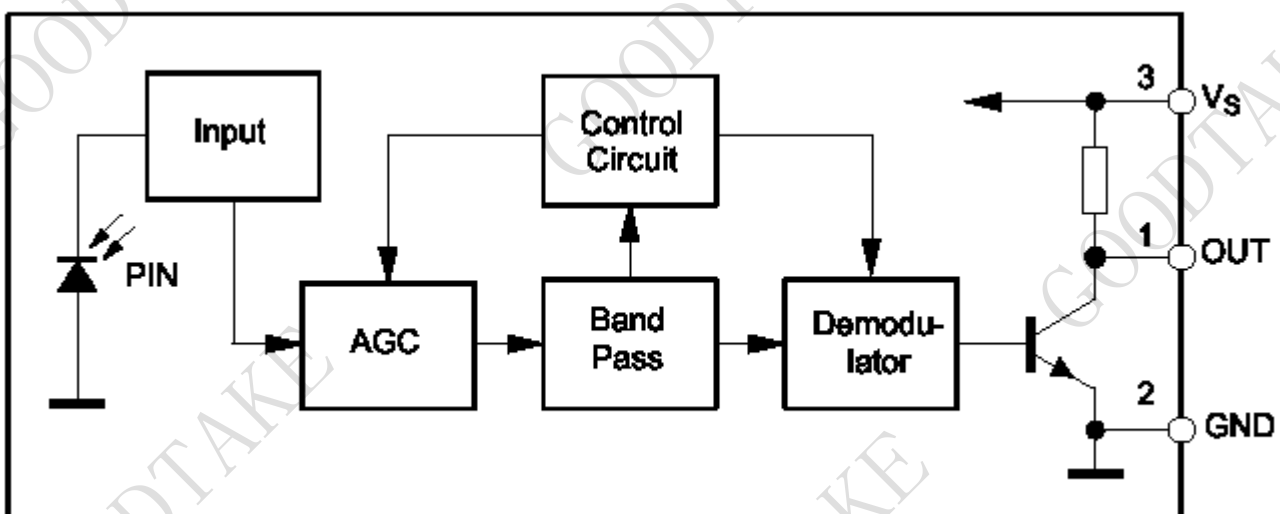

Application Circuit

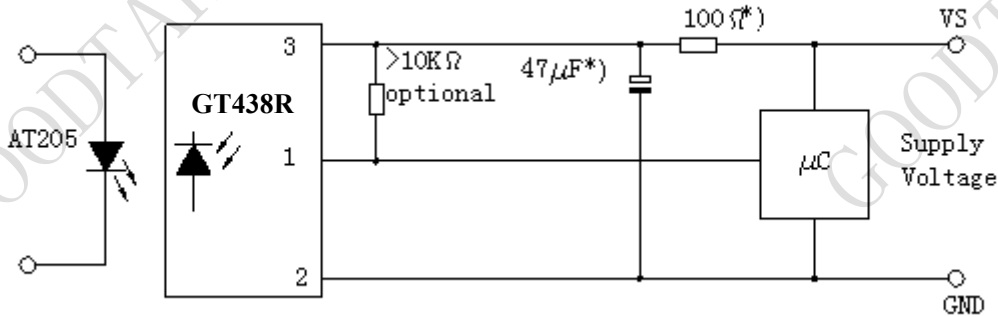

\*) recommended to suppress power supply disturbance

Absolute Maximum Ratings

Tamb = 25 °C

Parameter	Test Conditions	Symbol	Value	Unit
Supply Voltage	(Pin 2)	Vs	-0.3...6.0	V
Supply Current	(Pin 2)	Is	3	mA
Output Voltage	(Pin 3)	Vo	-0.3...6.0	V
Storage Temperature Range		Tstg	-25...+85	°C
Operating Temperature Range		Tamb	-25...+85	°C
Power Consumption		ptot	18	mW
Soldering Temperature	t ≅ 5s, 1 mm from case	Tsd	260	°C

Basic Characteristics

Tamb = 25 °C

Parameter	Test Condition	Symbol	Min	Typ	Max	Unit
Supply current	Vs = 5V, Ev = 0	Is		0.45	0.80	mA
	Vs = 3V, Ev = 0		0.15	0.35		
Operating Voltage	(Pin 3)	Vs	2.7	3.0	5.5	V
Transmission distance	IR diode AT205, IF = 400mA, Ev = 0		22	25		m
The minimum distance between the remote control and the receiver	IR diode AT205, IF = 400mA		0.3			m
Output Voltage High	Vs = 5V	VOSH	4.5			V
Output Voltage Low	IOSL = 2 mA, f = fo, tp/T = 0.4	VOSL			400	mV
Peak Wavelength	Internal IR filter	λ		940		nm
Carrier frequency	Internal BPF	fc		38		kHz
Output pulse width	Input burst = 600µS	Tp	400		800	µS
Angle of 1/2 Distance	Horizontal Half angle	½θ		±45°		Deg

**Test Condition:**

1. Test signal for output pulse width

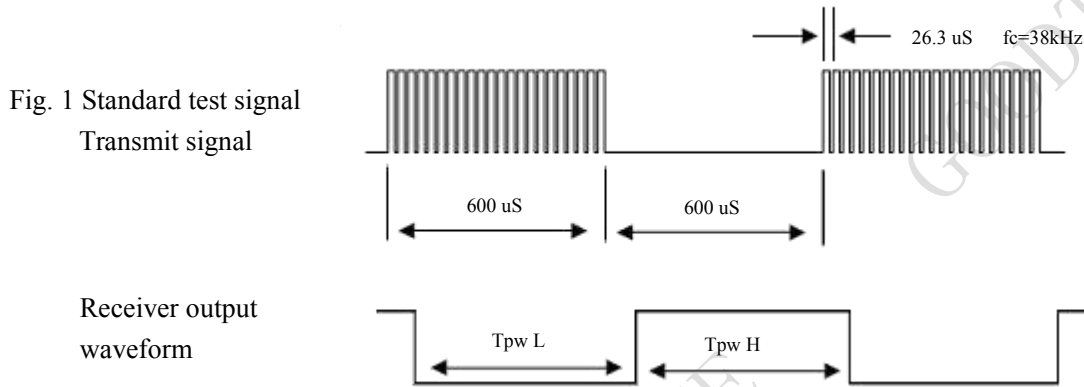

2. Arrival distance

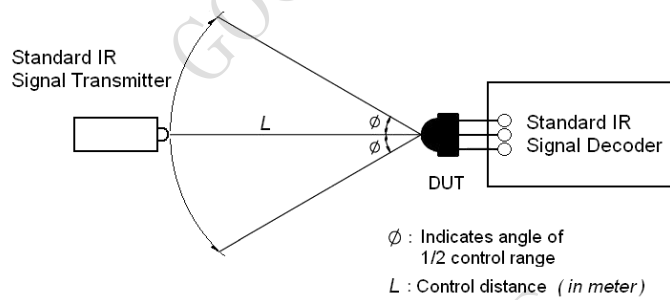

Test condition for measuring the control distance

3. Suitable Data Format

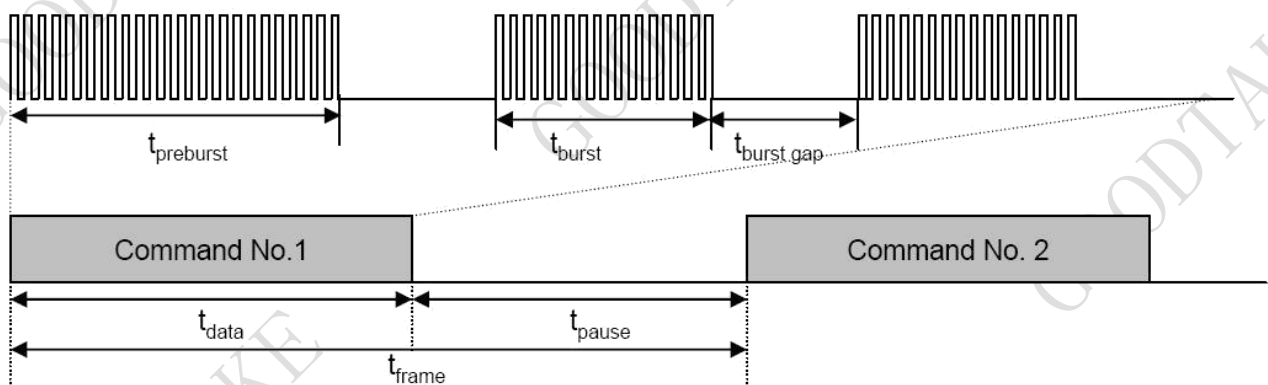

- Minimum burst length ( $t_{burst}$ ) of 15 pulses per burst
- Minimum burst gap time ( $t_{burst\ gap}$ ) 20pulse
- Minimum data pause time ( $t_{pause}$ ) > 22msec
- Suitable data format are : NEC Code, RC 5, RC 6 Toshiba

Characteristics Curve ( $T_{amb}=25^{\circ}C$  unless otherwise specified)

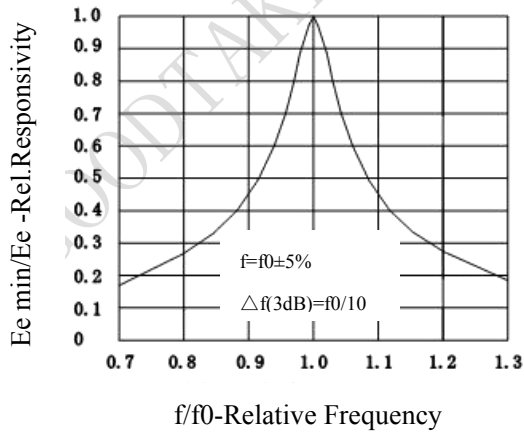

Figure.1-Frequency Dependence of Responsivity

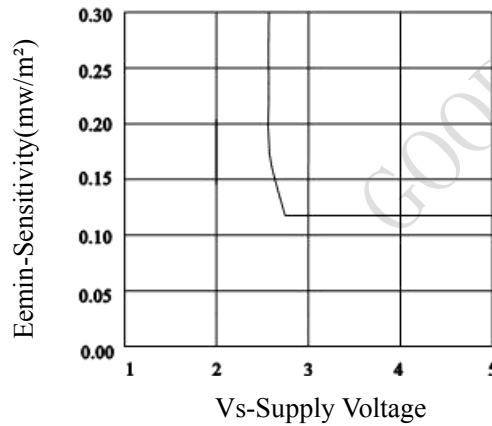

Fig.2-Sensitivity VS. Supply Voltage

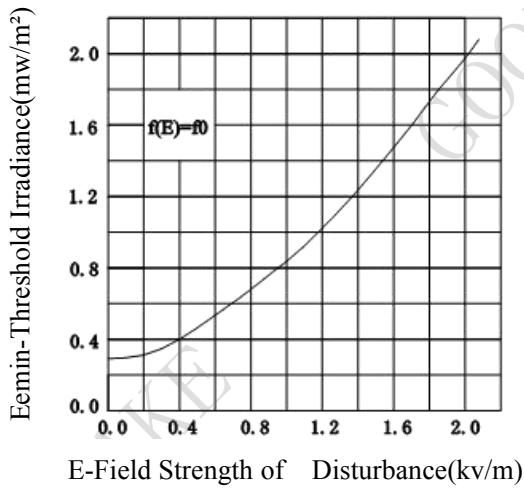

Figure.3- Sensitivity vs. Electric Field Disturbances

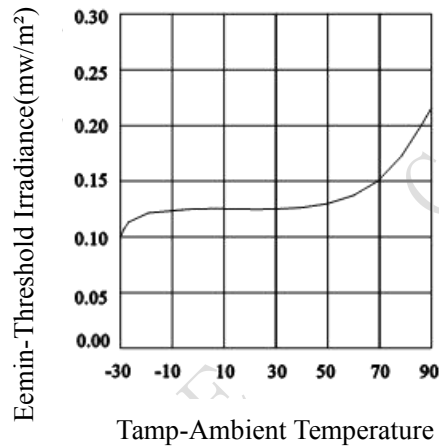

Fig.4-Sensitivity vs. Ambient Temperature

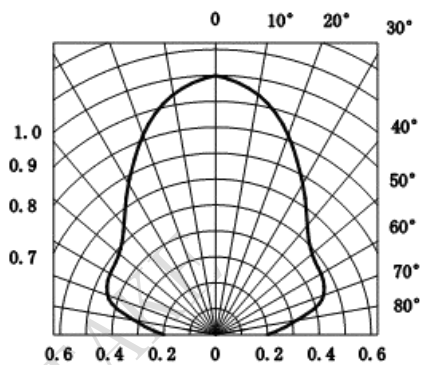

Fig.5-Vertical Directivity

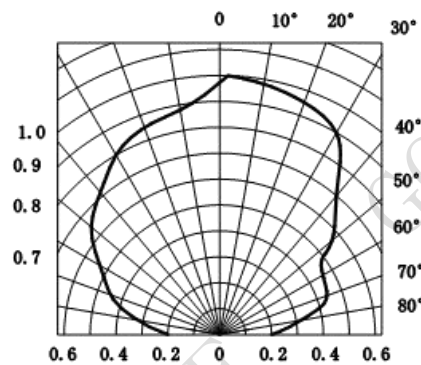

Fig.6-Horizontal Directivity

**Reliability Test**

TEST ITEM	TEST CONDITION	TEST TIME	SAMPLE NUM	OK NUM
High Temperature Storage	Ta=+85°C	t=240H	22	22
Low Temperature Storage	Ta=-25°C	t=240H	22	22
Resistance to soldering heat	Soak into solder tub of Tsd=260°C	1cycle 5sec	22	22
Electro Static Discharge	HBM C=100pF, R=1.5kΩ, 2kV,	each pin test once	22	22
High Temperature/Humidity*	Ta=+85°C, 85%RH	t=240H	22	22
Heat Cycle*	-25°C~+85°C(0.5H)	20cycle	22	22

**Note** : \*(electro-optical characteristics) shall be satisfied after leaving 2 hours in the normal temperature

**Package Outline**

Note: tolerance ±0.3mm

